

As submitted for: *Revue Française de Génie Civil* 3 (3–4), 1999, 61–89; also in: *Creep and Shrinkage of Concrete*, ed. by F.-J. Ulm, M. Prat, J.-A. Calgaro and I. Carol, Hermès Science Publications, Paris 1999, 61–89. Reprinted with updates in *Adam Neville Symposium: Creep and Shrinkage—Structural Design Effects*, ACI SP-194, A. Al-Manaseer, ed., Am. Concrete Institute, Farmington Hills, Michigan, 2000, 237–260.

Criteria for Rational Prediction of Creep and Shrinkage of Concrete

By Zdeněk P. Bažant¹, Fellow ACI

Abstract. The paper discusses the problem of formulation and evaluation of a prediction model for creep and shrinkage of concrete. Verification by comparisons to a few subjectively selected data sets is no longer justifiable because computers have made statistical comparisons to the complete existing data bank easy. However, statistics based on the data bank are insufficient. There are three further criteria: (1) After optimizing its coefficients, the model should be capable of providing close fits of the individual test data covering a broad range of times, ages, humidities, thicknesses, etc.; (2) the model should have a rational, physically justified theoretical basis, and (3) should allow good and easy extrapolation of the short-time tests into long times, high ages, large thicknesses etc. The last criterion is very important because good long-time predictions can be achieved only through updating based on short-time data for the given particular concrete. Various aspects of the B3 and GZ models recently considered by ACI Committee 209, as well as some aspects of the CEF-FIP model, are briefly analyzed in the light of these criteria, clarifying the way to move ahead.

1 Introduction

Creep of concrete as well as its shrinkage is a phenomenon of enormous complexity which has been researched for almost a century. It is very sensitive to the process of curing, variations of the environment, and especially the composition of concrete which varies widely among different localities and laboratories. Furthermore, the average creep and shrinkage in a cross section

¹Walter P. Murphy Professor of Civil Engineering and Materials Science, Northwestern University, Evanston, Illinois 60208.

of structural member depends on the shape and size of the cross section. For these reasons, considerable sophistication of the prediction model is inevitable.

Although the answer to the problem of optimum prediction is not unique at present, certain rather restrictive criteria that a good model should satisfy have nevertheless become clear. Most of them have recently been spelled out in the RILEM guidelines (RILEM 1995). The purpose of this paper is to concisely review these criteria and discuss how they are reflected in three recently developed prediction models, namely the B3 model (Bažant and Baweja 1994, 1995a,b,c, also in this volume), the GZ Model (Gardner and Zhao 1993), and the current CEB-FIP Model (1990). The first two, which are presented in this volume and have been under consideration in ACI Committee 209, will be addressed in more detail than the last.

At present, fortunately, there is no longer any shortage of test data. The RILEM data bank (an extension of the bank compiled in 1978 at Northwestern University) now exceeds 15,000 data points, with data from over 100 laboratories. The computerized data bank makes it easy to evaluate the statistics of prediction errors of various proposed models. Because many different concretes from different laboratories are combined in the data bank, the coefficient of variation of these errors is inevitably quite high, typically between 20% and 50%. For this and other reasons, verification of a prediction model cannot rely solely, and not even mainly, on the data bank. Other criteria must also be considered, especially those provided by a physically based theory, as discussed in the sequel.

2 Main Criteria of Evaluation

1. *Statistical comparison to data bank:* The model should achieve the lowest possible coefficients variation of the deviations of its predictions from the comprehensive data bank that includes all the relevant test data from literature (except those suspect for a good reason). The coefficient evaluation of the errors of the various aforementioned models are listed in Bažant and Baweja (1994) and in their paper on B3 Model in this volume.
2. *Fitting of individual test curves:* After optimal adjustment of parameters, very close fits of typical response curves should be achievable.
3. *Physically based theory:* The mathematical form of the model should conform to what is known from mechanical analysis and studies of the physical mechanisms.

4. *Extrapolation of short range data:* The model should

- (a) allow good extrapolations of short-time data to long times and long ages, of small thickness data to large thicknesses, etc., and
- (b) should have a form that allows the extrapolation to be done by linear regression—the only simple and foolproof method.

2.1 Unbiased Statistical Verification of Model

Criterion 1 means that comparisons should not be restricted to a limited set of test data. Unless the test data used for comparison are chosen truly randomly (e.g., by casting dice, or by a random number generator), the statistics can get blatantly slanted by using a selected data set. This was demonstrated by examples in Bažant and Panula (1980). They showed that:

- when 25 most favorable data sets among 36 available data sets for shrinkage were selected, the coefficient of variation of the errors of the model was reduced from 31.6 to 21.5%, and when 8 most favorable data sets were selected, it was reduced to 8.7%;
- when 8 most favorable data sets among 12 available data sets for creep were selected, the coefficient of variation was reduced from 52.2% to 20.7%.

Yet 8 data sets would impress most readers as plenty. This clearly shows the danger of making a subjective selection of the data sets with which a model should be compared. Unfortunately, such biased comparisons are often found in the literature (the bias is of course only subconscious; it is very tempting to conclude that ‘something must have gone wrong’ with the tests that deviate from a formula agreeing with other tests).

2.2 Verification of Model Form by Individual Tests

Comparisons with the complete data bank, however, can serve only as a partial validation of the model. The reason is that there are large random differences among data from different laboratories. The scatter band is very wide (Fig. 1a). The consequence is that a reasonable curve such as *a* in Fig. 1a does not give an appreciably higher coefficient of variation of the deviations from the test data than a totally unreasonable curve such as *b* (Fig. 1b). For example, one could superimpose sinusoidal oscillations of any frequency and an

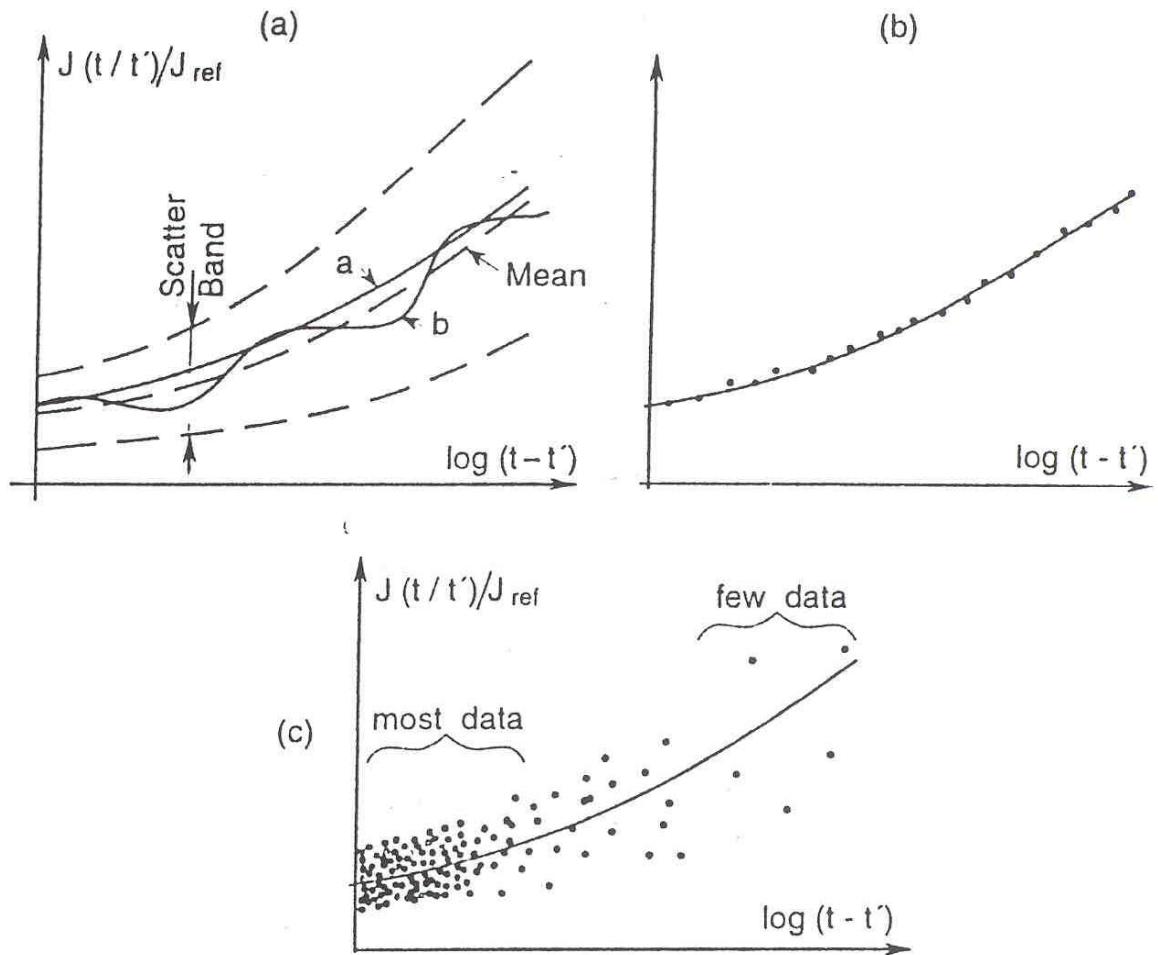

Figure 1: (a) Due to a very high scatter band width when all existing data are combined, reasonable (a) and unreasonable (b) curves have about the same coefficient of variation of errors; (b) a narrow scatter band width achievable only for individual tests; (c) the majority of existing test data is concentrated at short times (low creep durations and low ages at loading).

amplitude not exceeding a quarter-width of the scatter band without causing any appreciable effect on the coefficient of variation (curve *b*).

Such comparisons, therefore, cannot validate the shape of the curves of the model. For that purpose, it is necessary to check that the curves of the model agree with the experimental curves from various good *individual* tests, for which a very narrow scatter band is achievable (Fig. 1c).

A physical justification of the mathematical formula of the model is important because its practical use inevitably implies extrapolations far out of the range of the main existing evidence. One serious deficiency of the existing data bank is that most of the data points pertain to relatively short creep durations and ages at loading (for most data under 3 years, and for many under 1 year), to small specimen thicknesses, etc.

Consequently, blind statistics based on the comprehensive data bank imply improper weighting of the data, with a far greater weight put on the data for short times, short ages and small thicknesses than for long times, long ages, and large thicknesses (Fig. 1c), while the latter is most important. One way to circumvent this problem is to carry out the statistics separately for the individual decades of the logarithmic time scale, as presented for the B3 Model (Bažant and Baweja 1994).

2.3 Need for Short-Time Data Extrapolation by Linear Regression

The requirement for simplicity in the extrapolation of short-time test data means that all the free (adjustable) parameters of the model must be involved linearly, in order to allow linear regression. This is the only foolproof, unambiguous method of data fitting, a method that always works, a method that always gives a unique answer.

The B3 Model has been constructed so that all its 4 free (adjustable) parameters governing the basic creep and the drying creep (parameters q_2 , q_3 , q_4 and q_5) are involved linearly. Its compliance function has the basic form:

$$\begin{aligned}
 J(t, t') = & \underbrace{q_1}_{\text{asymptotic elastic}} + \underbrace{q_2 Q(t, t')}_{\text{aging viscoelastic}} + \underbrace{q_3 \ln[1 + (t - t')^n]}_{\text{nonaging viscoelastic}} \\
 & + \underbrace{q_4 \ln(t/t')}_{\text{aging flow}} + \underbrace{q_5 \sqrt{\Phi[h(t)] - \Phi[h(t')]}_{\text{drying creep}} \quad (1)
 \end{aligned}$$

where the individual terms represent physically well identifiable distinct components of creep, and the functions multiplying q_2, \dots, q_5 are fixed and do not

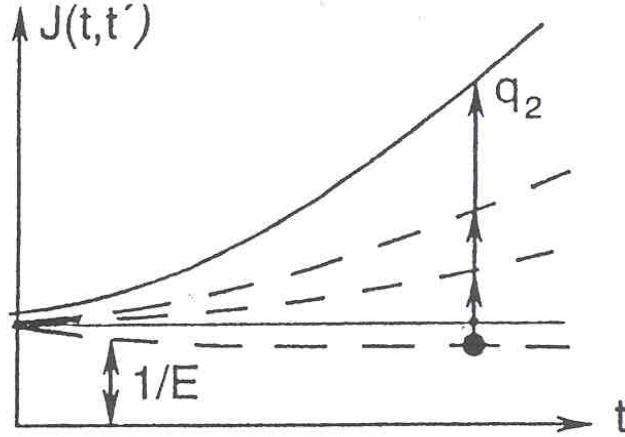

Figure 2: Vertical scaling parameter q_2 is the only linear parameter in GZ and CEB-FIP models

have to be changed in fitting the test data for any concrete, not even high strength or lightweight concrete; t = current time, t' = age at the application of sustained stress, $Q(t, t')$ = fixed function, $n = 0.1$, and Φ = function of the average relative humidity $H(t)$ within the specimen, which in turn depends on the environmental relative humidity h .

By contrast, the CEB-FIP and the GZ models, as well as the old ACI Model (ACI 209 R-92), have the basic form

$$J(t, t') = \underbrace{q_1 [E_{28}/E(t')]}_{\text{conventional elastic}} + \underbrace{q_2 F(t, t', h; q_3, q_4, q_5 \dots)}_{\text{all creep}} \quad (2)$$

in which F is a nonlinear function, E_{28} = chosen reference value (for age $t' = 28$ days) of Young's elastic modulus, and $E(t)$ = assumed conventional elastic modulus, which corresponds to the loading duration of about 0.01 day and has a given dependence on age t of concrete; q_1 in this case represents the value of the conventional elastic compliance $1/E$ at the age of 28 days giving the best fit of the given creep data.

In Eq. (2), only one elastic parameter, q_1 , and only one creep parameter, namely the overall multiplying factor q_2 (Fig. 2), are involved linearly, while the others are not. This nonlinearity, and the lack of separation of the compliance function into its additive components of different physical meanings, is a serious obstacle to using the CEB-FIP or GZ model for extrapolating given short-time data and for updating the model by fitting it to the given limited data for the given particular concrete. It makes these models inconvenient and unsuitable for such purposes.

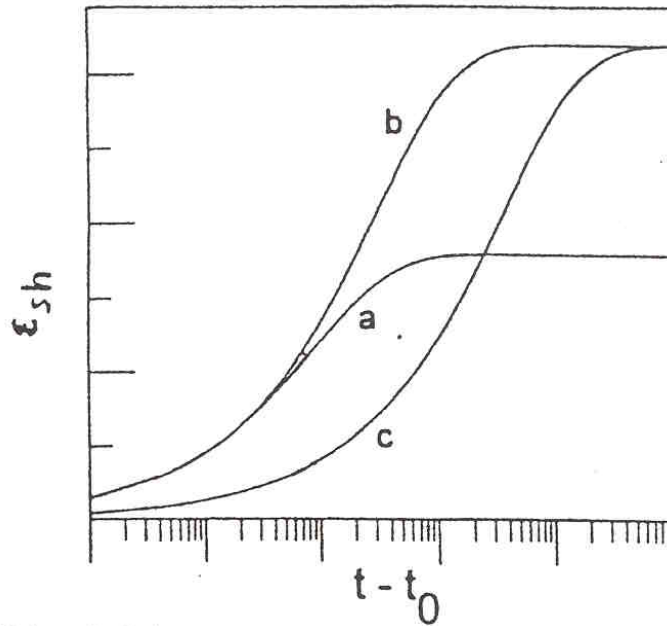

Figure 3: Possible shrinkage curves for specimens of various concretes with identical size, shape, age, and environment.

2.4 Taking Advantage of Constancy of Instantaneous Asymptotic Modulus

An experimentally proven feature of the B3 model, which simplifies the formulation but is not exploited to advantage in the GZ and CEB-FIP models, is the fact that if the curves of $J(t, t')$ for various ages t' at loading, plotted as functions of t^n , are extrapolated leftward, they all meet approximately at one point corresponding to q_1 (see Fig. 2.8 in Bažant and Baweja 1994 and in this volume). The load duration at which this value gets approached is too short to have any practical meaning (it is about 10^{-9} s). It corresponds to a hypothetical, truly instantaneous elastic compliance, whose inverse is called the asymptotic instantaneous elastic modulus.

The physical explanation is that the creep process has been found to possess no characteristic time below which the creep would cease to exist (in other words, the retardation spectrum is continuous and roughly constant into the shortest durations). By virtue of this fact, the term with q_1 in (1) is constant. But in (2) it is not, which unnecessarily increases the number of parameters (and also makes it impossible to capture creep for very short times, although this is not of concern in long life design).

2.5 Suitability of Model for Extrapolating Shrinkage Based on Water Loss

As far as shrinkage is concerned, it was recently shown that no model can be fitted to short-time data unambiguously. The problem is that for all the models it is possible to find shrinkage curves with very different final values that differ extremely little up to and somewhat beyond the shrinkage half time τ_{sh} , as shown by curves *a* and *b* in Fig. 3 (see also precise plots in Fig. 2.11 in Bažant and Baweja (1994 and in this volume) or Fig. 2 in Bažant and Baweja 1995b). It is also possible that one concrete shrinks much less than another for the first few years but its final shrinkage will be much higher (curves *a* and *c4*) in Fig. 3). Consequently, the shrinkage data on normal size specimens would have to have a duration of at least 5 to 10 years in order to predict the 30 or 60 year shrinkage with any reasonable confidence. A way out of this dilemma is as follows.

It is necessary that every short-time shrinkage test to be used for calibration be accompanied by simultaneous measurements of the weight loss due to water evaporation (Bažant and Baweja 1994, 1995b). The idea is that the weight loss follows a similar curve as the shrinkage curve but, in contrast to shrinkage, the final water loss can be easily and reliably predicted—by heating the specimen in an oven at the end of the short-time shrinkage test and scaling then the final water content from zero humidity to the given humidity according to the well known shape of sorption isotherms (see Bažant and Baweja 1994, 1995).

So the requirement that a linear regression be possible can be applied only for those data that are accompanied by simultaneous measurements of weight loss. For the B3 Model, a transformation to a form that allows linear regression of the water loss data is possible. In that manner one can find the shrinkage halftime τ_{sh} , and then, knowing $\tau_{sh}\varepsilon_{sh,\infty}$ by a second linear regression (Bažant and Baweja 1994, 1995b). For the GZ and CEB-FIP models, such linear regressions are not available, which makes these models unsuitable for shrinkage extrapolation based on water loss.

Figs. 1.3 and 1.4 of Bažant and Baweja (1994, see this volume) and Figs. 1 and 4 Bažant and Baweja (1995b) show examples of extrapolation exercises in which it was pretended that only the initial data points from long range measurements were known. The up-dated predicted curves obtained agree very well with the subsequent measurements.

Calibration of the main parameters of the model by short-time tests ought to always be practiced when dealing with creep sensitive structure. At present, it offers the only way of achieving dependable long-time predictions.

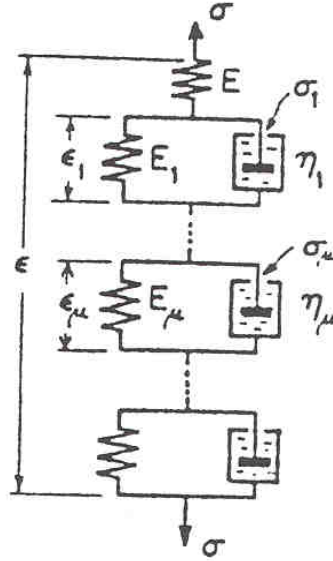

Figure 4: Kelvin chain model with age-dependent spring moduli $E_\mu(t)$ and viscosities $\eta_\mu(t)$.

3 Physical Aspects of Prediction Model

Currently, a number of physical requirements and mechanisms are understood sufficiently well to base on them the prediction model. There are essentially seven physical mechanisms that allow making inferences for the proper mathematical form of the creep and shrinkage prediction model.

1. Solidification as a mechanism of aging, particularly at early times.
2. Microprestress relaxation as a mechanism of long-time aging (Bažant et al. 1997).
3. Bond ruptures caused by stress-influenced thermal excitations controlled by activation energy (Wittmann 1974).
4. Diffusion of pore water.
5. Surface tension, capillarity, free and hindered adsorption, and disjoining pressure.
6. Cracking caused by self-equilibrated stresses and applied load.
7. Chemical processes causing autogenous volume change and microprestress.

These mechanisms will be invoked in the concise discussion that follows.

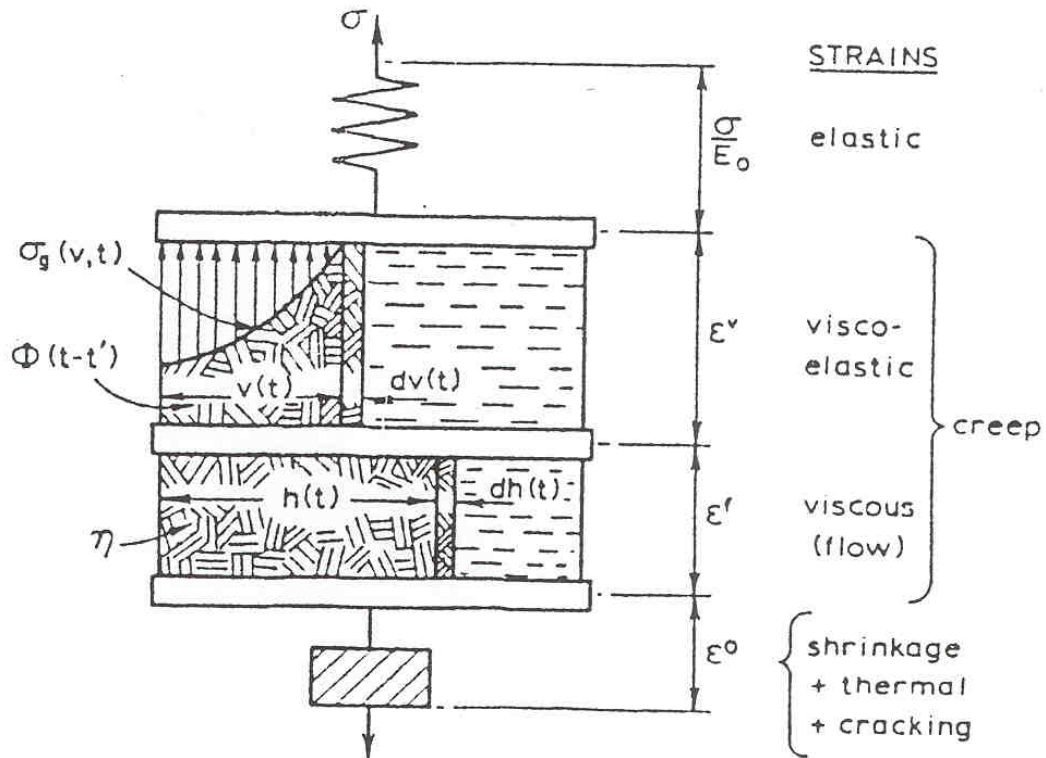

Figure 5: Solidification model for deposition of layers of hydrates on the pore walls in cement paste (Bažant and Prasannan 1989).

3.1 Thermodynamic Restrictions for Solidifying Aging Materials

Any aging linear viscoelastic behavior can be described with any desired accuracy by the Kelvin chain model consisting of springs and dashpots (e.g. RILEM 1988; Fig. 4). The moduli E_μ and the viscosities η_μ of the units of the chain ($\mu = 1, 2, \dots, N$) are functions of the age of concrete which must be non-decreasing if the material is hardening (solidifying) rather than softening. There exists a least-square algorithm to determine these functions from the given compliance function $J(t, t')$.

However, for compliance function models that do not heed certain restrictions, such as the GZ and CEB-FIP models, this algorithm yields for functions E_μ and η_μ values that are negative for some periods of time or that decrease, rather than increase, for some periods of time (e.g. RILEM 1998). Each of these two features (1) is thermodynamically inadmissible according to the concept of solidification, which causes strengthening of the microstructure due to the progress of the hydration reaction, and (2) causes convergence difficulties in computer solutions.

In the solidification theory (Bažant and Prasannan 1989), it is assumed

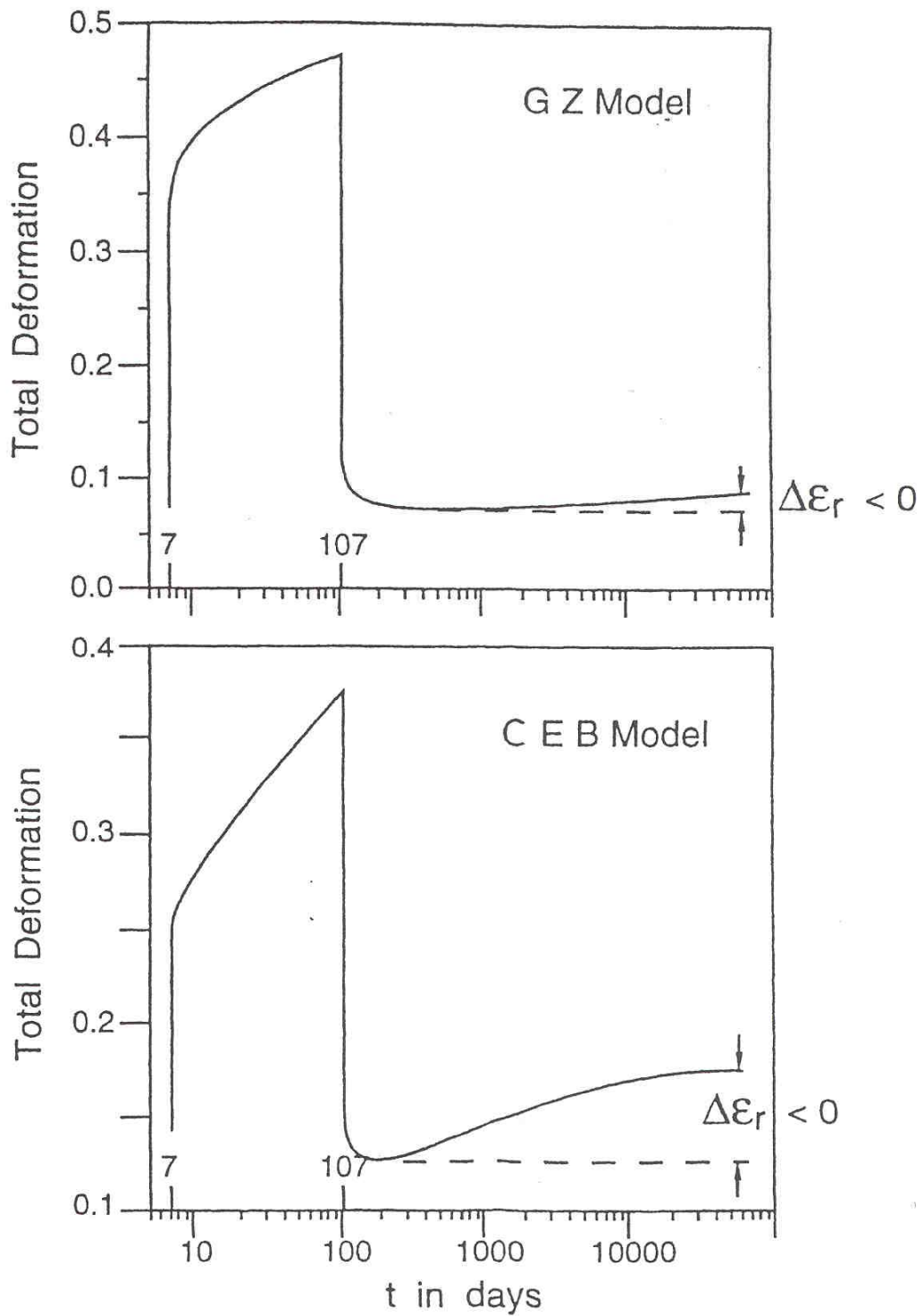

Figure 6: Unrealistic recovery reversal obtained by principle of superposition for GZ and CEB-FIP models.

that the decrease of creep with an increase of the age t' at loading is due to the deposition of layers of new calcium silicate hydrates on the pore walls (Fig. 5). At the instant these layers solidify on the pore walls, they do not share in carrying the externally applied load. From this property, a special mathematical form of the compliance function ensues. This form does not allow, in the Kelvin chain approximation, the viscosities and elastic moduli of the chain to become negative for any period of time, and also does not allow that they would decrease for any period of time.

For compliance functions chosen empirically, without regard to the solidification theory, it is in general possible (and normally happens) that a creep recovery curve calculated from the compliance function according to the principle of superposition is non-monotonic, i.e., the recovery curve exhibits a reversal into negative recovery, as seen in Fig.6. According to the solidification theory, a non-monotonic recovery curve (recovery reversal) is impossible.²

Fig.6 shows two examples of the recovery reversals exhibited by the GZ model and by the current CEB-FIP model. These reversals imply that some of the viscosities or elastic moduli of the Kelvin chain approximations for these models are negative for some periods of time, or that the moduli or viscosities of the Kelvin chain units decrease for some periods of time. Such behavior, which can never occur for the B3 Model (a mathematical proof exists), is thermodynamically inadmissible according to the solidification theory. Besides, it may cause convergence problems in creep analysis by finite elements.

Another thermodynamic restriction of the solidification theory is that the stress relaxation curves may not cross the horizontal axis into stress values of opposite sign. The B3 model guarantees that this can never happen. However, for both the current CEB-FIP Model and the GZ Model, the crossing of the relaxation curves into values of opposite sign does occur; see Fig. 7. Such behavior again means that some moduli or viscosities of the Kelvin chain

²The recovery curves obtained according to the principle of superposition are guaranteed to be always monotonic if and only if

$$\partial^2 J(t, t') / \partial t \partial t' \geq 0 \quad (\text{non-divergence condition}) \quad (a)$$

for all t and t' (which means that the slopes of the curves of $J(t, t')$ versus time t for the same t do not diverge, i.e., they increase with an increasing age at loading t'). It is easy to check that this condition is always satisfied by Eq. (1) for the B3 model, not only for the basic creep ($H(t) = \text{constant}$) but also for the drying creep (a decreasing $H(t)$). In fact, model B3 was formulated with this restriction in mind. But this condition is not satisfied for the GZ and CEB-FIP models (nor the short form of B3 model). The condition that the relaxation curves obtained from the principle of superposition may never change their sign (i.e., may never cross the horizontal axis) is related to this condition (Bažant and Huet 1998)

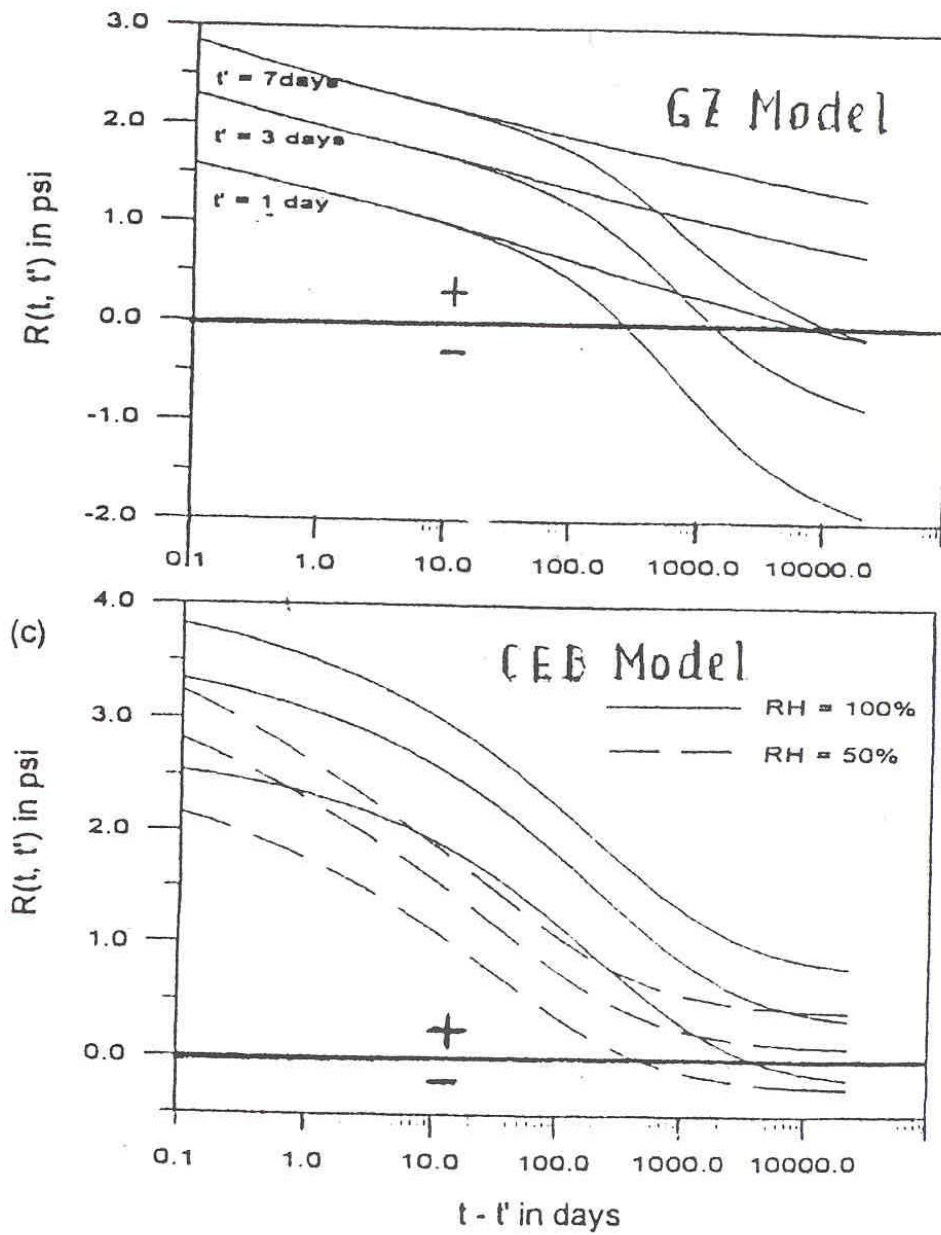

Figure 7: Unrealistic change of sign of relaxation curves obtained according to the principle of superposition. Strain 10^{-6} applied at age t' . R.H. = 100% upper branches, 50% lower branches ($t_0 = 1$ day). GZ model: $f'_c = 50$ MPa, CEB-FIP model: $f'_c = 35$ MPa.

approximation can become negative for some periods of time, or that they may decrease for some periods of time, which again is physically incorrect and may engender convergence problems.

3.2 Explicit Determination of Kelvin Chain Moduli

In large-scale finite element calculations, the use of the superposition integrals based on the compliance function is very inefficient (RILEM 1988). It is far more efficient to convert the integral-type viscoelastic stress-strain relation into a rate-type stress-strain relation, which does not involve history integrals. This is achieved by approximating the compliance function with the spring-dashpot Kelvin chain model, which can be done with any desired accuracy.

For a compliance function of arbitrary form, the determination of the Kelvin chain approximation requires a rather cumbersome numerical algorithm (RILEM 1988). This algorithm needs to be used in the case of the GZ and CEB-FIP models. However, for the compliance function of the solidification theory, used in the B3 model, the determination of the Kelvin chain approximation is very easy. It can be accomplished by an explicit one-line formula for the elastic moduli of the Kelvin units in the chain, proposed by Bažant and Prasannan (1989) and improved by Bažant and Xi (1995).

3.3 Absence of a Characteristic Time as a Reason for Choosing Power Functions

The creep process in the nonaging constituents of the cement paste, as well as the chemical process of hydration, are not known to possess any characteristic time, i.e., a time at which the behavior would drastically change. Therefore, each of these processes as some function $f(t)$ of time t ought to satisfy the relation

$$f(t_1) / f(t_2) = f(t_1/t_2) \quad (3)$$

where t_1 and t_2 are any two times. A power function, $f(t) = t^n$ ($n = \text{constant}$), obviously satisfies this functional equation, and it can be shown that the power function is the only solution. Because creep does not significantly affect the degree of hydration, and thus the progress of aging (maturing), the decrease of creep compliance amplitude (as well as elastic compliance) with increasing age should be a power function, which is given in the B3 model as t^{-m} . For a time period in which the power function for aging is nearly constant and thus cannot alter creep, the creep function should likewise be a power function; this

is the period of initial creep for $t - t' \ll t'$ (e.g., the first week for $t' = 1$ month, or the first 3 months for $t' = 1$ year).

This consideration justifies the use of power functions of time in the expression of the compliance rate based on the solidification theory; see Eq. 1.6 in the B3 Model (Bažant and Baweja 1994), which is the simplest combination of these power functions satisfying the physical requirements of the solidification theory. Besides, the use of power functions leads to the best agreement with test data.

When the creep and the aging interact, the response does not have to be (and is not) a power function. In fact, the long-term creep curves approach asymptotically logarithmic functions of time, which is because the aging viscous flow becomes dominant. However, the short-time creep curves ought to be power functions as long as the aging for the duration of the load remains insignificant. This condition is satisfied by the solidification theory used in the B3 Model.

3.4 Microprestress Relaxation and the Question of Characterizing Creep Aging by Strength Gain

Unlike the age effect on creep, the age effect on the strength of concrete is relatively short-lived (Fig. 8). The increase of strength due to hydration stops at about 1 year of age, whereas the reduction of creep for a fixed load duration with increasing age at loading continues for many years. Consequently, it is questionable to characterize this reduction of creep by the known strength gain function, as done in the GZ model. The long time aging cannot be captured in such a manner.

A physical explanation why the strength gain function cannot be used in a model for creep is that the source of long-time aging of concrete is the relaxation of microprestress caused in the microstructure by the volume changes of various constituents during the initial hydration (Bažant et al. 1997). By contrast, the principal source of short-time aging is the volume growth of hydration products in the pores.

3.5 Activation Energy Theory and Power Curves

The activation energy theory (also called the rate process theory) governs all the processes that are thermally activated, which includes both creep and hydration reactions. In this theory, the temperature dependence is generally given by the Arrhenius formula of the type $\exp(-Q/RT)$ in which Q is the

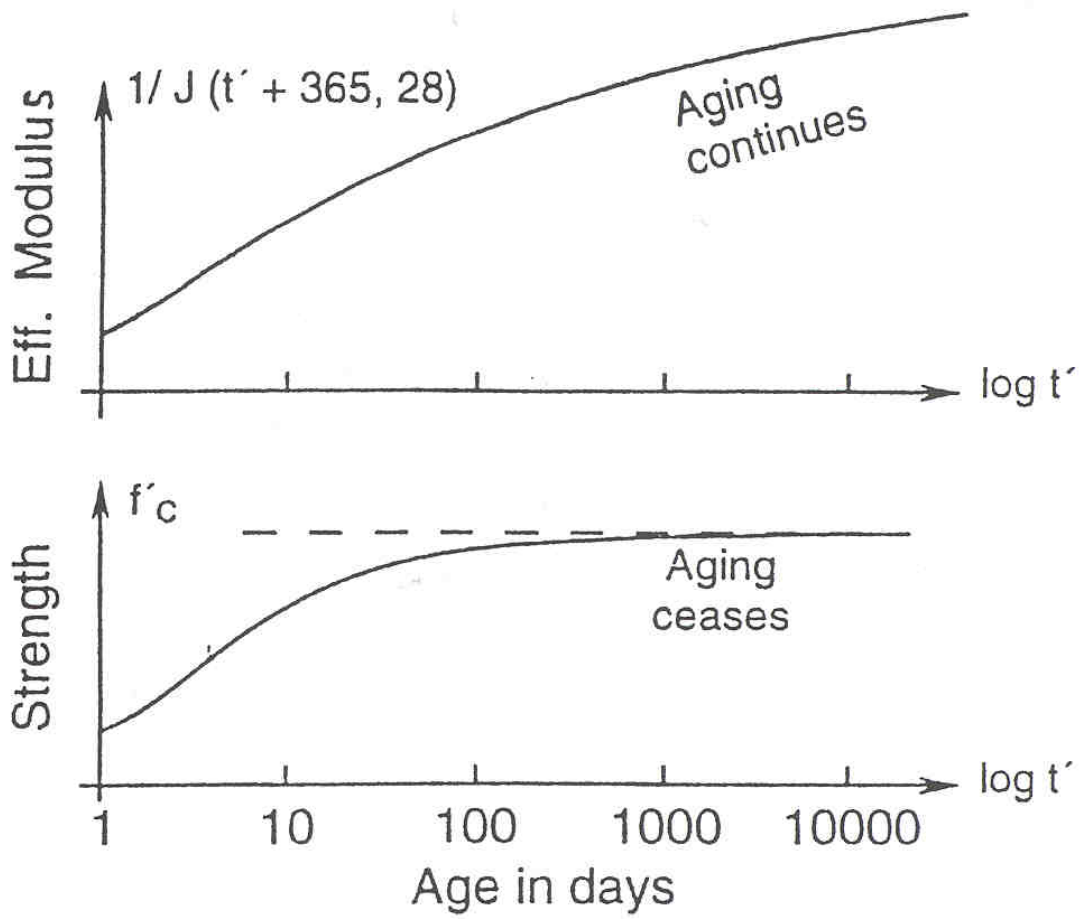

Figure 8: Effective modulus (inverse of compliance) grows long after the strength has ceased to grow.

activation energy, T is the absolute temperature, and R is the gas constant. Different activation energies apply for the creep and the hydration.

The activation energy underlies the definition of the equivalent age (maturity) in the B3 model. However, deeper inferences can be made from the activation energy theory. As Wittmann (1971a,b, 1974) demonstrated, under certain reasonable simplifying assumptions the activation energy theory again shows that the short-time creep curves ought to be power curves.

3.6 Diffusion Theory for Pore Water

A number of inferences, validated by experiments, can be made from the diffusion theory for the movement of pore water. This is in spite of the fact that the diffusion of water in concrete is highly nonlinear (since the diffusion coefficient strongly decreases with a decreasing relative humidity in the pores). Three simple properties result from the diffusion theory.

3.6.1 Final Asymptotic Form and Boundedness of Shrinkage Curve

The drying shrinkage is caused by the loss of moisture. After all the moisture evaporation needed to restore thermodynamic equilibrium with the environment has evaporated, the shrinkage must stop. So, because the water loss is finite, the drying shrinkage must have a finite asymptotic value (Fig. 9).

It may further be noted that a part of shrinkage is due to chemical reactions, which represents the chemical or autogeneous shrinkage. These reactions also come to a stop once all the constituents have reacted. Therefore, this part of shrinkage must have a finite asymptotic value, too, and so must the total shrinkage (Fig. 9).

Only few careful and statistically significant measurements had a long enough duration to document the approach to a final shrinkage value of concrete; see the data points in Fig. 9 (Wittmann et al. 1987) which have a high statistical significance because they represent the average of 36 identical, precisely controlled, shrinkage tests carried out at the Swiss Federal Institute of Technology. On the other hand, the existence of a final shrinkage value has been very well documented for hardened cement paste, thanks to the fact that the specimens can be made thin enough to dry to an equilibrium water content within a short enough time (shorter than the time required to get a Ph.D.); e.g. Wittmann (1974). Since the shrinkage of cement paste is what causes the shrinkage of concrete, it follows that the shrinkage of concrete, too, cannot be unbounded. When the hardened cement paste in concrete stops shrinking, the concrete stops shrinking.

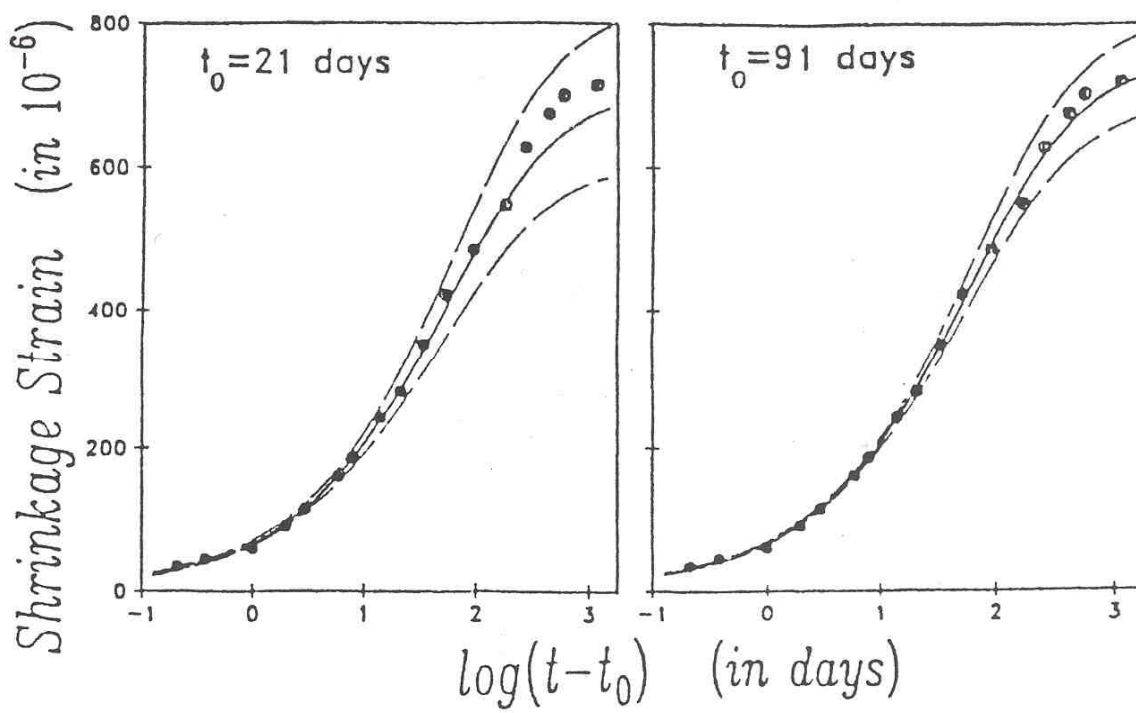

Figure 9: Tests by Wittmann et al. (1987) confirm that shrinkage does not terminate with a rising straight line (as in Fig. 10) and that a finiteness of shrinkage is a reasonable theoretical conclusion.

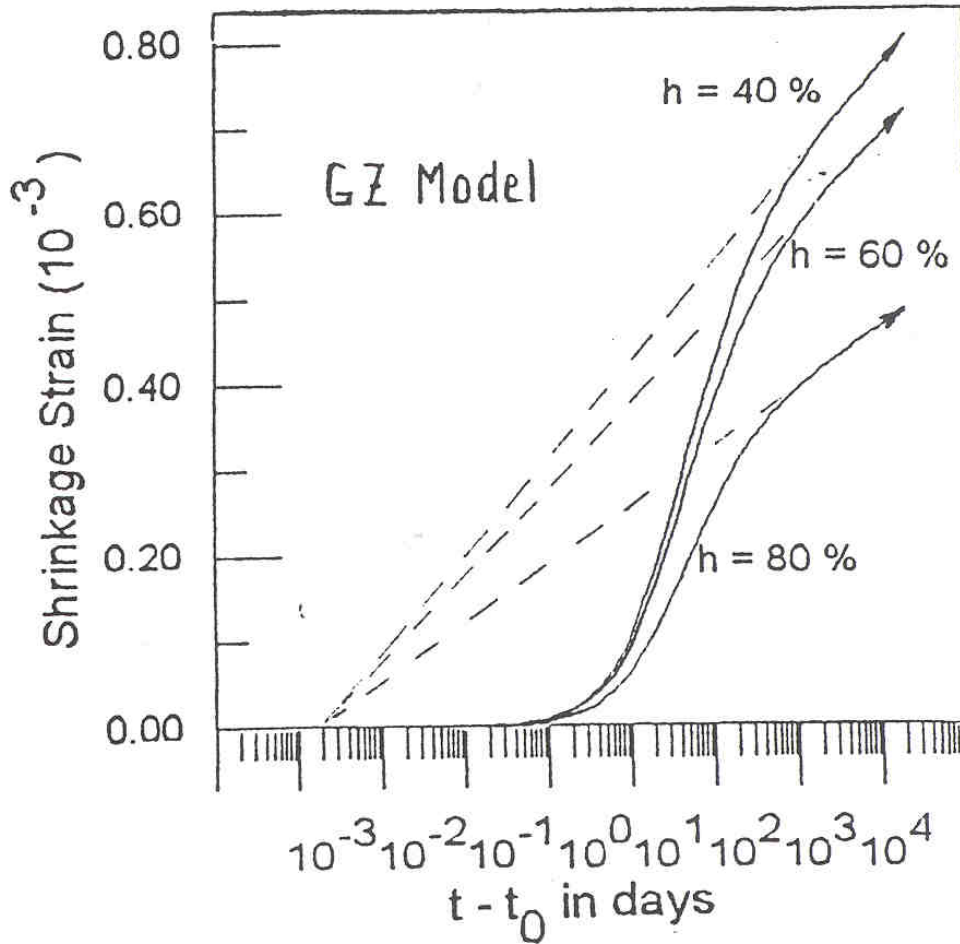

Figure 10: Typical shrinkage curves of GZ model (h = environmental humidity).

The GZ Model does not agree with this fact. In that model, shrinkage is unbounded. Moreover, the shrinkage curve in the semi-logarithmic plot terminates with an inclined rising straight line (Fig. 10). To justify it, Gardner and Zhao cited the measurements of Troxell et al. (1958). However, these old data, pertaining to a low quality concrete, are questionable and represent an anomaly among the numerous shrinkage data sets available. Unlike these singular data, the bulk of other data does not support the assumption that the shrinkage curve would terminate with a rising straight line in the semi-logarithmic plot; see the numerous measurements of shrinkage curves from many sources plotted in Bažant et al. (1991).

3.6.2 Initial Form of Shrinkage and Drying Creep Curves

According to the diffusion theory (Bažant and Kim 1991), the shrinkage and drying creep curves should begin as $\sqrt{t - t_0}$, where t = current time (age), and t_0 = time at the start of drying. This condition, requiring that the initial slope of the curve of the logarithm of shrinkage strain ε_{sh} versus the logarithm of drying duration be $-1/2$ (Fig. 11), even for a nonlinear diffusion equation,

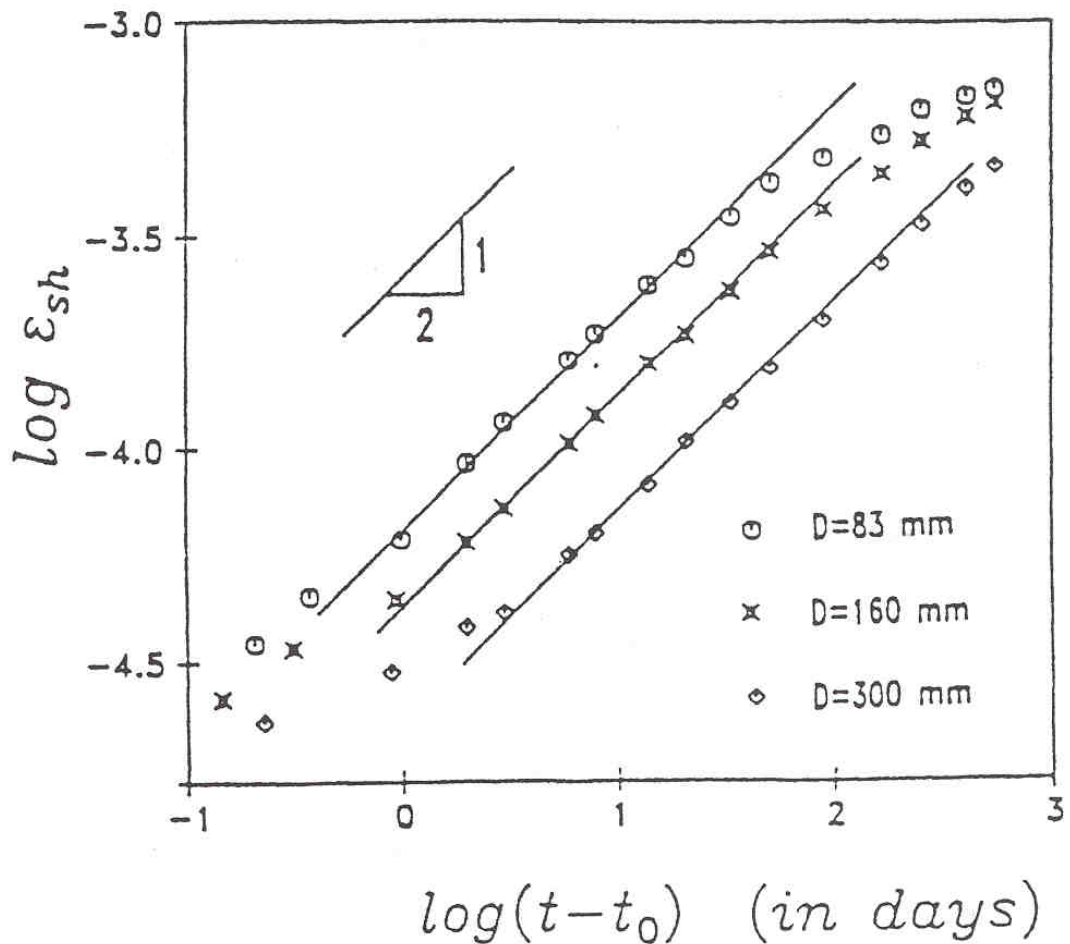

Figure 11: Test data of Wittmann et al. (1987) demonstrating that the plot of the logarithm of shrinkage versus the logarithm of drying time is initially a straight line of slope $-1/2$ (the small deviations for very small times are due to neglecting finiteness of surface transmissivity).

is verified by the B3 Model. But this condition is violated by the GZ and CEB-FIP models.

3.6.3 Exponential Approach to the Final Asymptotic Shrinkage Value

The diffusion theory further indicates (Bažant and Kim 1991) that the final shrinkage value should be approached in an exponential manner. In particular, the difference of shrinkage from the final shrinkage should at the end decrease in proportion to $\exp[-\kappa(t - t_0)^{1-n}]$ where $\kappa = \text{constant}$ and n may be taken as $1/2$. This property is satisfied by the tanh-function in the B3 model, and in fact represents the reason why the tanh-function replaces the previously used function $[1 + \tau_{sh}/(t - t_0)]^{-1/2}$ (which fits the available data equally well). This property, too, is valid despite the nonlinearity of the diffusion equation.

A simple formula for the creep curve can be obtained by asymptotic match-

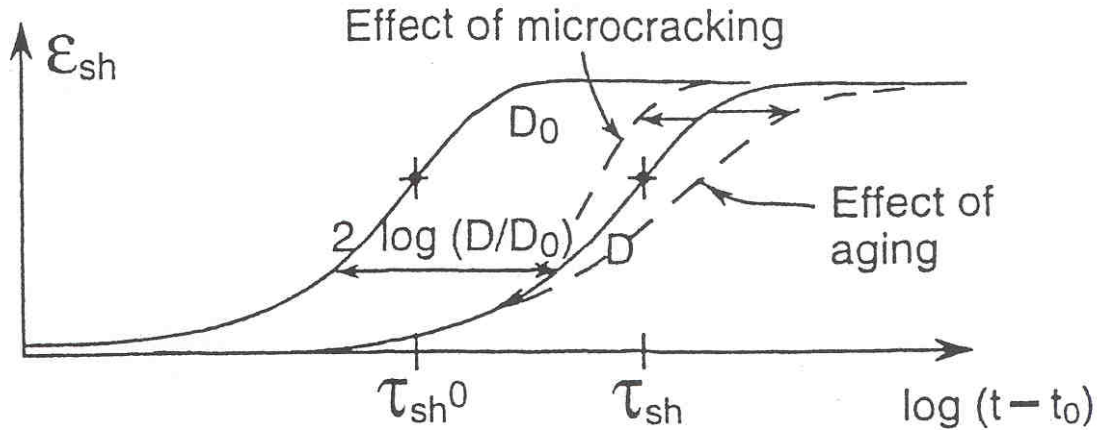

Figure 12: Shrinkage curve viewed as interpolation between theoretically determined asymptotic behaviors for short and long drying times.

ing, i.e. interpolation between the short-time and long-time asymptotic forms of the creep curve; see Fig. 12. The tanh-function is the simplest ‘interpolation’ formula that satisfies both the short-time and the long-time asymptotic forms.

3.6.4 Size effect on shrinkage halftime

The diffusion theory, despite its nonlinearity, indicates that, for geometrically similar bodies, the halftime of shrinkage, τ_{sh} , should be proportional to D^2 where D = thickness of the cross section. This property is well verified by many data (e.g., Bažant et al. 1987; see Fig. 13 and 14).

Other data show some deviations occurring at longer times (Fig. 14). This can be explained by two causes: the simultaneous aging, and the microcracking. They usually have the opposite effects at long times. Thus, they often nearly cancel each other, with the result that usually the scaling $\tau_{sh} \propto D^2$ still works reasonably well.

3.6.5 Shape Effect on Shrinkage

The diffusion theory makes it also possible to determine theoretically the factor k_s that gives the correction to the shrinkage halftime depending on the shape of the cross section. Its theoretically calculated values (based on the plots in Bažant and Najjar 1972), provide a good agreement with test data and are used in the B3 Model.

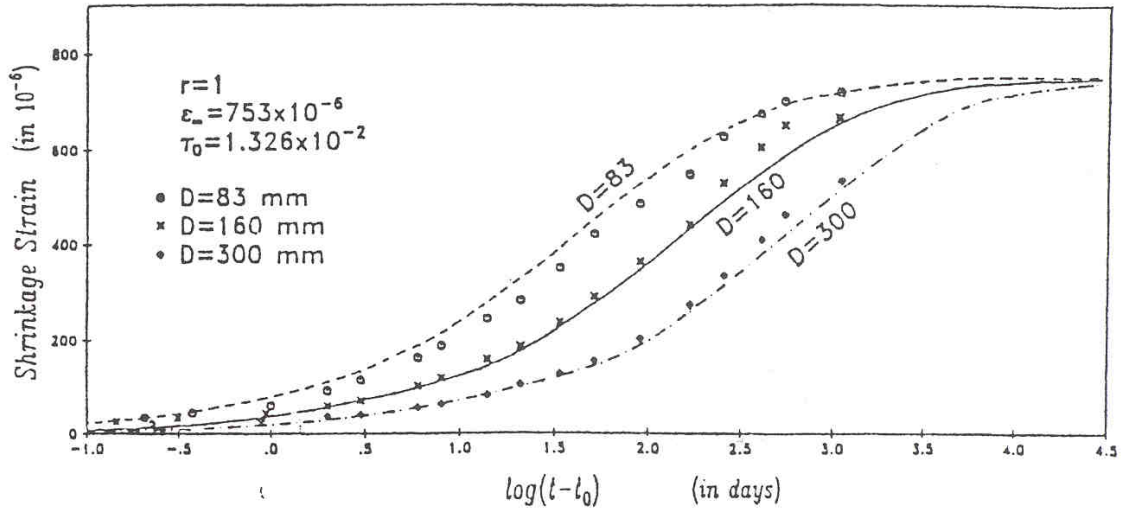

Figure 13: Shrinkage measured by Wittmann et al. (1997) (data points) compared to curves for which the halftimes are scaled as the square of diameter of the cylinder, as required by diffusion theory.

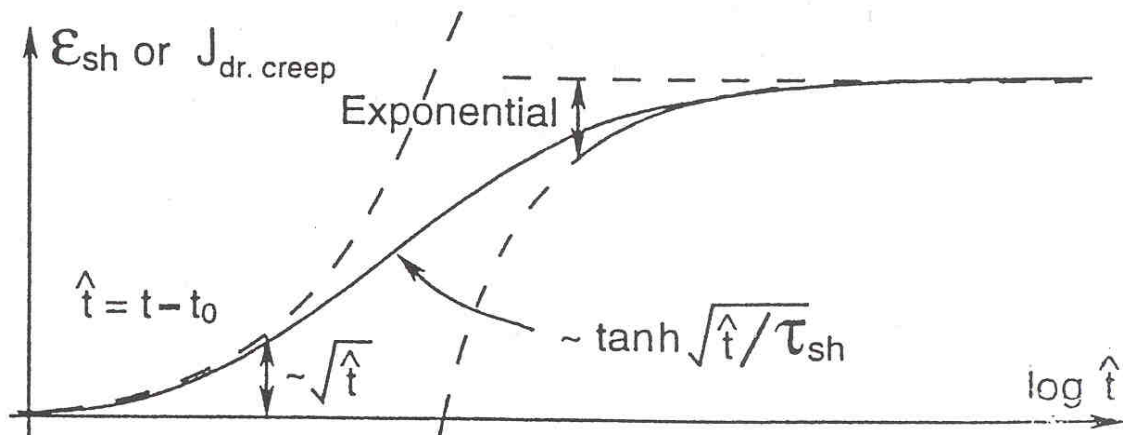

Figure 14: According to diffusion theory, a change of diameter from D_0 to D causes a horizontal shift by distance $2 \log(D/D_0)$. The effects of cracking and aging distort it but in opposite ways.

3.6.6 Drying Creep, Flow, and Aging or Non-Aging Viscoelasticity

The diffusion source of drying creep further indicates that the additional creep due to drying should be related to the shrinkage function, as formulated in the B3 model (in a manner that satisfies the non-divergence condition). The initial and final shapes of the drying creep curves, as well as the effect of cross section thickness, should therefore be similar to those for shrinkage, which is reflected in the B3 model.

Furthermore, it is advantageous to separate in the creep formula the additive components of creep having different physical origins and meanings, as already shown in Eq. (1).

3.6.7 Effect of Environmental Humidity

Since the environmental humidity represents a boundary condition for the diffusion equation, and the solutions of the diffusion equation scale down if the value of boundary humidity is reduced, the diffusion theory indicates that the influence of environmental humidity should come as a multiplicative factor in the formula of the shrinkage curve. Thus, a change in the environmental humidity should result in vertical scaling of the shrinkage curve and of the drying creep curve.

Such scaling is verified by test results. This contrasts with the effect of cross section thickness, which is manifested, in the semi-logarithmic plot, by horizontal shifts of the shrinkage curve and of the part of the creep curve attributed to drying.

3.7 Effect of Cracking

The tensile stresses caused by nonuniformity of drying throughout the cross section are known to produce tensile cracking. The cracking causes that the observed shrinkage of specimens is less than the true shrinkage of the material. This difference is one cause of the drying creep effect (Pickett effect).

Although generally the effects of cracking seem hard to quantify by simple formulas, they have to be taken into account in finite element analysis. Since cracking contributes an additional deformation, the drying creep should properly be taken into account as an additive term rather than a multiplicative term, as done in the B3 Model.

4 Closing Comment

Creep and shrinkage effects are most important for various advanced modern designs—daring structures of large span, height or slenderness, innovative structural forms, structures made of high strength concrete or lightweight concretes, structures exposed to severe environments or those carrying high permanent loads. For such structures, the effectiveness of the updating of the prediction model based on limited short-time tests of the given concrete is the paramount criterion. Such updating offers the only way to achieve reliable long-time predictions.

Acknowledgment: Partial support under National Science Foundation Grant MSS-9114476 to Northwestern University is gratefully acknowledged.

References

- ACI 209 R-92, “Prediction of creep, shrinkage and temperature effects in concrete structures,” *American Concrete Institute*, Detroit 1992 (minor update of original 1972 version).
- Bažant and Baweja (1994). “Creep and shrinkage prediction model for analysis and design of concrete structures (Model B3).” Report, Northwestern University, submitted to ACI Comm. 209, published in this volume.
- Bažant, Z.P., and Baweja, S. (1995a), in collaboration with RILEM Committee TC 107-GCS, “Creep and shrinkage prediction model for analysis and design of concrete structures – model B3” (RILEM Recommendation). *Materials and Structures* (RILEM, Paris) 28, 357–365; with Errata, Vol. 29 (March 1996), p. 126.
- Bažant, Z.P., and Baweja, S. (1995b). “Justification and refinement of Model B3 for concrete creep and shrinkage. 1. Statistics and sensitivity.” *Materials and Structures* (RILEM, Paris) 28, 415–430.
- Bažant, Z.P., and Baweja, S. (1995c). “Justification and refinement of Model B3 for concrete creep and shrinkage. 2. Updating and theoretical basis.” *Materials and Structures* (RILEM, Paris) 28, 488–495.
- Bažant, Z.P., Hauggaard, A.B., Baweja, S., and Ulm, F.-J. (1997). “Microprestress-solidification theory for concrete creep. I. Aging and drying effects”, *J. of Engrg. Mech. ASCE* 123 (11), 1188–1194.
- Bažant, Z.P., and Huet, C. (1998). “Thermodynamic functions for aging viscoelasticity: integral form without internal variables,” *Int. J. of Solids and Structures*—in press.
- Bažant, Z.P., and Kim, Joong-Koo (1991). “Consequences of diffusion theory for shrinkage of concrete.” *Materials and Structures* (RILEM, Paris) 24 (143), 323–326.
- Bažant, Z.P., Kim, Joong-Koo, and Panula, L. (1991). “Improved prediction model for time-dependent deformations of concrete: Part 1—Shrinkage.”

- Materials and Structures* (RILEM, Paris) 24 (143), 327–345.
- Bažant, Z.P., and Najjar, L. J. (1972). “Nonlinear water diffusion in nonsaturated concrete.” *Materials and Structures* (RILEM, Paris), 5, 3–20.
- Bažant, Z.P., and Panula, L. (1980). “Creep and shrinkage characterization for prestressed concrete structures.” *J. of the Prestressed Concrete Institute*, 25, 86–122.
- Bažant, Z.P., and Prasanna, S. (1989). “Solidification theory for concrete creep: I. Formulation.” *ASCE Journal of Engineering Mechanics* 115 (8) 1691–1703.
- Bažant, Z.P., and Raftshol, W. J. (1982). “Effect of cracking in drying and shrinkage specimens.” *Cement and Concrete Research*, 12, 209–226; Disc. 797–798.
- Bažant, Z.P., Wittmann, F. H., Kim, Jenn-Keun, and Alou, F. (1987). “Statistical extrapolation of shrinkage data - Part I: Regression.” *ACI Materials Journal*, 84, 20–34.
- Bažant, Z.P., and Xi, Y. (1995). “Continuous retardation spectrum for solidification theory of concrete creep.” *J. of Engrg. Mech. ASCE* 121 (2), 281–288.
- CEB-FIP Model Code (1990), Design Code, Thomas Telford, London.
- Gardner, N.J., and Zhao, J.W., “Creep and shrinkage revisited,” *ACI Materials Journal* **90** (1993) 236–246. Discussion by Bažant and Baweja, *ACI Materials Journal* **91** (1994), 204–216.
- RILEM Techn. Com. TC-107 (1995) (Z.P. Bažant and I. Carol, main authors), “Guidelines for characterizing concrete creep and shrinkage in structural design codes or recommendations.” *Materials and Structures* 28, 52–55.
- RILEM Committee TC 69 (1988). “State of the art in mathematical modeling of creep and shrinkage of concrete,” in *Mathematical Modeling of Creep and Shrinkage of Concrete*, ed. Z.P. Bažant, J. Wiley, Chichester, U.K., and New York, 1988, 57–215.
- RILEM (1996) Data Bank on Concrete Creep and Shrinkage, prepared by RILEM Comm. TC-107 subcommittee chaired by H. Müller, available from Karlsruhe University, Germany.
- Troxell, G.E., Raphael, J.M., and Davis, R.W. (1958). “Long time creep and shrinkage tests of plain and reinforced concrete.” *Proc. ASTM* 58, 1101–1120.
- Wittmann, F.H. (1971a). “Vergleich einiger Kriechfunktionen mit Versuchsergebnissen.” *Cement and Concrete Research* 1, 679–690. Wittmann, F.H. (1971b). “Kriechverformung des Betons unter statischer und dynamischer Belastung.” *Rheological Acta* 20, 422–428.
- Wittmann, F.H. (1974). “Bestimmung physikalischer Eigenschaften des Zementsteins,” *Deutscher Ausschluß für Stahlbeton*, Heft 232.
- Wittmann, F. H., Bažant, Z.P., Alou, F., and Kim, Jenn-Keun (1987). “Statistics of shrinkage test data.” *Cement, Concrete and Aggregates* (ASTM), 9 (2), 129–153.

FIGURES — See the ACI Proceedings or the Journal