

RÉUNION INTERNATIONALE
DES LABORATOIRES D'ESSAIS
ET DE RECHERCHES SUR
LES MATÉRIAUX ET LES
CONSTRUCTIONS

THE INTERNATIONAL UNION
OF TESTING AND RESEARCH
LABORATORIES FOR MATERIALS
AND STRUCTURES

LES RÉSINES DE SYNTHÈSE DANS LA CONSTRUCTION

SYNTHETIC RESINS IN BUILDING CONSTRUCTION

Colloque de la RILEM RILEM Symposium
Paris, 4-6 septembre 1967

1

ÉDITIONS EYROLLES
61, boulevard Saint-Germain · PARIS V^e

1970

A METHOD OF TESTING RELAXATION AND DURABILITY UNDER STRESS OF RESIN CONCRETES

Z. P. BAZANT ⁽¹⁾ & V. WEISS ⁽¹⁾

There are two effects that decide about the durability of a structure : a structure may fail either by the action of load (the strength for a long-term load application being less than that for a short-time one), or because of physical reasons-chemical ageing and aggressive effects of external media. Whenever the two effects combine, their resultant action is far more pronounced than a simple superposition of the two effects would indicate ; this holds true to a greater extent for plastics than for other structural materials. This is the reason why the service life of load-carrying structures made of plastics must be determined on stressed specimens exposed to the effect of the medium in which the structures are intended to serve*.

A simple method** applicable to plastics alone has been evolved by Bazant and Skupin (1, 2, 3) ; it works with strip specimens bent to form an arc between fixed stops and exposed in this condition to the action of the respective medium. Even though the loading regime at constant strain with stress relaxation is different from that at constant stress, and the relation between the two regimes is rather complicated, the combined effect of load and external medium is marked enough even at constant strain. The evaluation of the relaxation measurements in which the stress varies both length and cross-wise of the specimen may be facilitated by tabulating the geometric parameters of the arc, the so-called elastica (2).

As the tests of the life time of concretes and similar brittle materials under stress as hitherto carried out on specimens loaded by springs (4) are rather laborious and costly, we have set out to find a new method that would enable us to test resin concretes in large series. Basing on the experiences gathered in the tests with bent strips, we have developed a method of testing resin concretes, mortars and concretes at constant strain***.

The test specimens are in the form of circular cylindrical rings shaped like the letter C ; they are cast in steel moulds (fig. 1) and their dimensions are as follows :

(1) Dipl. Ing. CSc, Scientific Worker, Building Research Institute, Technical University, Prague, Czechoslovakia.

*/ Cf. a paper by L. Skupin presented to this Colloquium

**/ Czechoslovak Patent Application PV 6350-65

***/ Czechoslovak Patent Application PVA 2649-66

RELAXATION AND DURABILITY UNDER STRESS OF RESIN CONCRETES

	o.d.	height	wall thickness
for resin concretes and cement mortars with maximum aggregate size to 4 mm	15 cm	5 cm	2 cm
for cement concretes with maximum aggregate size to 25 mm	30 cm	10 cm	7.5 cm

A set screw placed in the gap between the ring ends (fig. 2) bears through a spherical surface against a smooth steel plate. The place in which the two pieces contact is protected by a rubber hose threaded over it ; in an aggressive medium the ends of the hose and all uncovered steel surfaces are also properly sealed and protected by paraffin or other suitable material. The set screw (or in another version, a precision wedge) produces a permanent constant enlargement of the gap and thus subjects the ring to a bending stress.

It serves the given purpose very well to subject the specimen to a bending stress because under it the rigidity and the load carrying capacity are reduced by the diminishing undestroyed thickness of the section at a substantially faster rate than under simple tension or compression. The stresses vary both along the length and across the thickness of the ring, the most dangerous section sustaining pure bending combined with some tension. The shape of the ring suffers virtually no change after the initial strain has been induced ; in the evaluation of the results we may consider it circular and moreover assume that the plane shape of the sections has been maintained. An evaluation of the results is possible because the law of creep is essentially linear for resin concretes, mortars and cement concretes, similarly as it is in the tests made with bent strips (3).

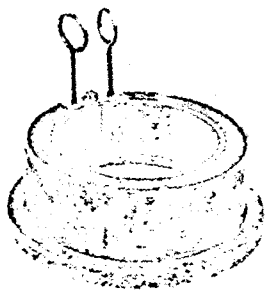

Fig. 1 - Mould for casting the test rings.

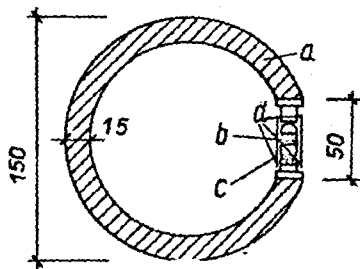

Fig. 2 - Schematics of the durability test of ring at constant strain a - ring ; b - set screw ; c - rubber hose ; d - seal.

The force produced in the ring and transmitted by the set screw is measured by a compensation method. The gap is enlarged by means of a dynamometer with a soft spring by small values δ and 2δ read on a dial gauge (fig. 3). The force produced in the ring which corresponds to zero enlargement of the gap at a given instant and thus also to the instantaneous rigidity is obtained by extrapolation of the measured forces.

LES RÉSINES DE SYNTHÈSE

A force of about 15 to 20 kp and an initial enlargement of about 4 mm correspond to a permanent load to half the short-term strength of a resin-concrete ring ; a strain of about $\delta = 0.2$ mm may be used for the compensation measurements. For rings made of cement mortar, the stresses and thus also the strains must be reduced against the preceding case by a factor of about 10, and our demands on the accuracy of the results made less stringent.

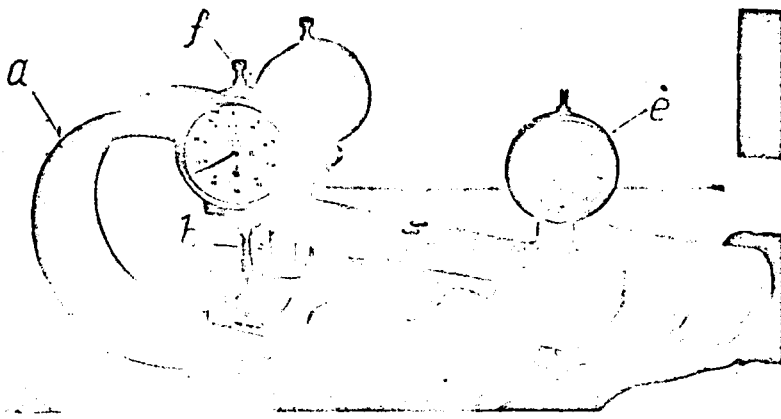

Fig. 3 - Ring in the course of force and rigidity measurements a - ring ; b - set screw ; e - dynamometer with tensioning screw ; f - strain indicating dial gauge.

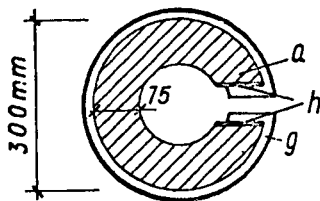

Fig. 4 - Schematics of the durability test of ring under constant force a - ring ; g - spring ; h - bearing plates.

As to the cement concrete : even when larger rings are used, the initial enlargement of the gap turns out to be very small, about 0.05 mm at a force of approximately 50 kp while the strain still usable in the compensation measurements is $\delta = 0.005$ mm at most. Such a situation makes, of course, high claims on the precision with which to prepare and carry out the tests. It is, therefore, recommended for such cases to choose the regime of an approximately constant load, viz. either to increase the strain - by equalizing the force and tightening the set screw at certain (exponentially growing) time intervals - so as to raise the force always to its initial value, or to load the ring permanently by means of a spring, preferably also a C-shaped one (fig. 4).

The effect of aggressive media on specimens under stress can be observed directly on data showing the decrease of the instantaneous rigidity, an information that is equally necessary in an analysis of the short-term deformation and stability of structures after the load has been applied for some time.

RELAXATION AND DURABILITY UNDER STRESS OF RESIN CONCRETES

The decrease is given by the mean weakening of all the sections while the long-term strength depends on the statistically largest weakening, i.e. on the development of the critical crack in a single dangerous section ; as we can see, the relation between the decrease of rigidity and the long-term strength is by no means a simple one. It is, therefore, expedient when testing for the life time of stressed specimens in a given medium to continue the test to failure. In order to do away with the necessity of waiting till the stressed specimen fails spontaneously, a matter that is always time consuming (and in certain cases nigh to impossible at constant strain), it is suggested to produce failure of the ring after a period of loading at constant strain, by a sudden addition of load (enlarging the gap) and thus determine the instantaneous short-term carrying capacity of the specimen. The dynamometer that serves in the compensation measurements of the force produced in the ring may be used for that purpose with advantage. Even though the evaluation is more involved than in a test at constant stress or strain to failure (a hypothesis concerning the superposition of deteriorations under variable stresses must be introduced in advance), the test itself is faster and simpler by far.

We have started an extensive programme of tests according to the method just described involving rings made of polyester or epoxy resin concretes, polymer-cement and cement mortars kept in dry condition, in water, under alternately dry and wet conditions, in acid and alkaline media, on organic solvents and – in the case of specimens containing cement – also in a sulphate solution. A detail report on the results of tests now in progress will be presented at a later date.

REFERENCES

- (1) SKUPIN L. : *Prüfung der Dauerhaftigkeit bei Plasten* (Plastverarbeiter, 1966, N° 6, p. 352).
- (2) BAZANT Z.P. : *Stress Relaxation Testing of Plastics and Fibre-Glass Plastics* (In Conference on experimental methods of investigating stress and strain in structures, Building Research Institute, Technical University, Prague, 1965, pp. 797-809).
- (3) BAZANT Z.P. : *Mathematische Ermittlung der rheologischen Eigenschaften von glasfaserverstärkten Kunststoffen unter Berücksichtigung der Berechnung von Konstruktionen* (Plaste und Kautschuk, 1965, N° 7, 8).
- (4) MOSKVIN V.M., PODVALNYY A.M. : *On the Frost-Resistance of Concrete under Stress* (in Russian) (Beton i zhelezobeton, 1960, N° 2, pp. 58-64).

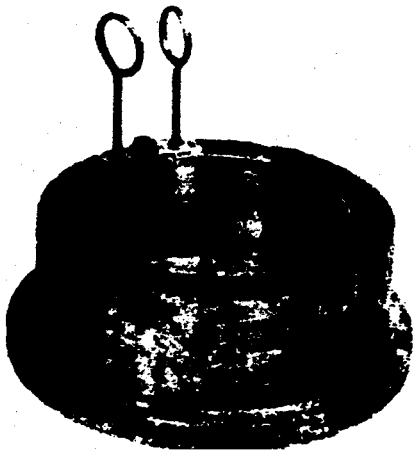

Fig. 1

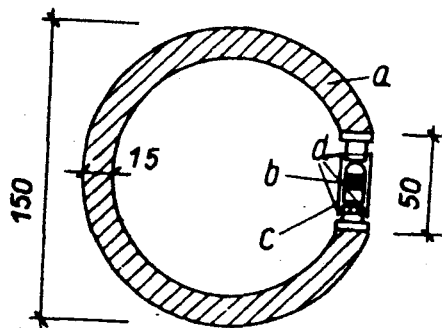

Fig. 2

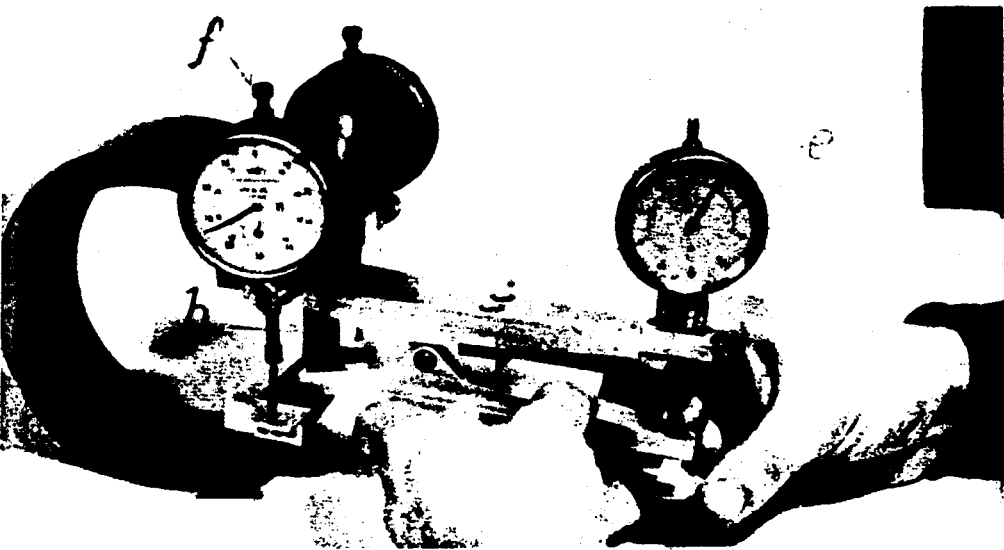

Fig. 3

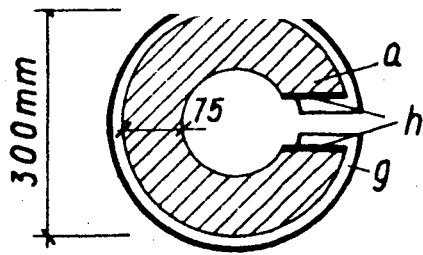

Fig. 4